

Engineering progress
Enhancing lives

ESSENCE W67 HI²
ALUMINIUM WINDOW
SYSTEM

 **REHAU** | **elviol**
Window Solutions

**INNOVATIVE TECHNOLOGIES_
ELVIAL PRE-ANODIZING 2IN1_
ELVIAL I² INSULATION TECHNOLOGY_
BE DIFFERENT.**

ESSENCE STATEMENT.

THE ELVIAL SIGNATURE IS PROUDLY INSCRIBED ON THIS LINE, THAT PROPOSES A DIFFERENT WAY TO EXPERIENCE SPACE. IT CREATES FEELINGS WITH THE USE OF DESIGN AND ATMOSPHERE WITH TECHNOLOGIES. THE SPECS ARE AMONG THE FINEST IN ITS CATEGORY. RELIABILITY AND VERSATILITY ARE AMONG ITS KEY FEATURES.

THE MINIMAL LINES AND TOP NOTCH TECHNOLOGIES ARE COMBINED TO ILLUSTRATE A POINT WE CONSIDER ESSENTIAL. A QUALITY PRODUCT GENERATES QUALITY WORK AND, ULTIMATELY, SUPERIOR EXPERIENCES. THIS COLLECTION CAN HELP ARCHITECTS MATERIALIZE MANY POSSIBILITIES AND IT IS ARCHITECTS' CREATIVITY THAT CAN EXPAND THE COLLECTION'S POTENTIAL FURTHER.

**CREATE THE TOTAL EXPERIENCE OF SPACE.
CREATE NEW POSSIBILITIES.**

ESSENCE W67 HI²

ESSENCE W67 HI² is a different way to experience space. It puts mind over matter. It uses design to create feelings and technologies to create atmosphere. The specs are always important but it is the ELVIAL signature that ensures you'll get the best of everything.

Limiting the contour to what is absolutely necessary. Assuring that ESSENCE W67 HI² harbours every technology required to create ideal atmosphere and ensure energy efficiency and security. This is how we design.

**HARMONY BECOMES TACTILE.
GET THE BEST OF EVERYTHING.**



ESSENCE W67 HI²

Add an obvious asset to any project with ESSENCE W67 HI². It is the go to solution when flexibility and dependability are of utmost importance.

ESSENCE W67 HI² ML | for Multilock groove mechanism

ESSENCE W67 HI² CE | for European groove mechanism

Classic Linear typologies

Windows,

Balcon doors,

Window Walls

ESSENCE W67BS HI²

This solution promises minimal look and elegance. It delivers beauty and comfort. ESSENCE W67BS HI² is the harmony in visible form.

ESSENCE W67BS HI² ML | for Multilock groove mechanism

ESSENCE W67BS HI² CE | for European groove mechanism

Blind Sash typologies

Windows,

Balcon doors,

Window Walls



Essence W67BS HI²

When creativity is an integral part of your day job, devising new opportunities and way of seeing things is part of the process and a great reward.

Broadening this sense of possibility is what we do with this solution.

We combined minimal looks with optimal technologies to produce unparalleled quality.

67







FREE DOM

This solution can produce aesthetic effects of iconic level.

The slim lines, the variety of finishes and the meticulous detailing can be tailored to accommodate all your concepts and plans.





VIEW

Open a whole new world
of possibilities.

The system that allows
for streamlined minimal looks and
unique architectural creations.





INS PIR ATION

Picture this.

A space filled with light, that offers a fabulous view to skies in urban or rural environments.

And in that space the exquisite props that complete the scene.

This picture will find an impeccable frame in ESSENCE W67 HI².

Then your main concern about the surroundings will be the delicate details. Art, plants or objects.

Essence W67 HI²

This solution combines elegant style and optimal technologies to open new possibilities for you and your clients.

It is tailored to ensure superior implementation according to your project specs.









DESIGN SIGNATURE

Superiority is a result of a fortunate conjugation between a unique idea and the flawless implementation.

Whether you come up with a plan for a small scale private project or an imposing public construction you can rest assured that this solution is what you need to masterfully materialize it.

Attention to Detail.

An ingenious take on elegance.

The precise lines, slim contours and attenuated particulars that make the ESSENCE collection aesthetically exceptional are present in this solution.

Put your creativity to work to see what it can do for you.



MAXIMUM VIEW

The conjunction of sashes never looked sleeker. The integrated adjoining profile minimizes the central vertical profile view to just 78mm and the perimetrical contour to 66mm only. Boundaries are being eliminated.



UNOBSTRUCTED TRANSIT

Open passage thanks to just 20mm height frame. Ideal for PWD and children.



FIRM & MINIMAL

Specially designed T - profiles with inner reinforcement upping of just 10mm, ideal for sturdy constructions with wide openings, consistent with modern architectural trends.



INDUSTRIAL DESIGN WINDOW WALLS

This exclusively developed and uniquely designed collection of profiles allows you to create window walls with an exemplary industrial look and feel.



SAME LEVEL APPEARANCE INWARDS

Ultimate same level appearance on the inner side of the window, thanks to the application of a specially designed frame. Ideally featured to the application of a hidden tilt and turn mechanism.

Extra Features.

Form follows function, they said.

We glorified form by concealing the functional components.

Hinges to open or tilt that go undetected.





Extra Features.

Handles so sophisticated that render grace to industrial design.

AVAILABLE IN ML EDITIONS

COLORS



Black



Inox
Satine



Natural
Anodizing



AVAILABLE IN CE EDITIONS



COLORS



Black



White



Grey

The **TECHNOLOGY**

You can feel it on a cold night.
You'll appreciate it on a hot day.
You'll love this when you run your budget.

We have developed the Advanced Sealing System to water-proof any construction. Vulcanization and assembly render all parts of the window impermeable.

OPTIMAL THERMAL INSULATION

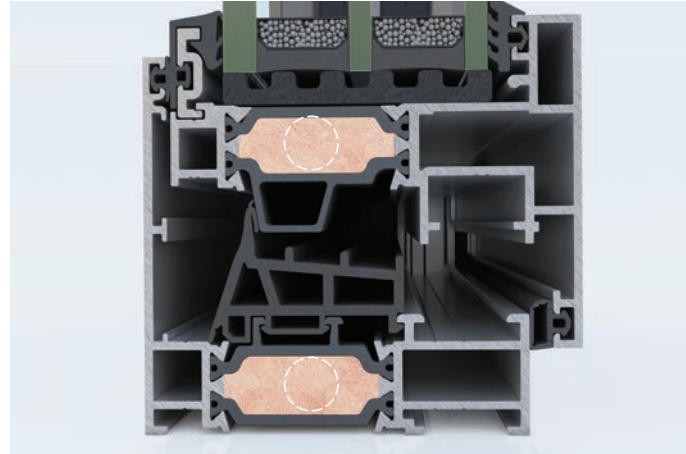

ELVIAL I² _ INNOVATIVE INSULATION TECHNOLOGY

The Innovation ELVIAL I² Technology is applied to all system profiles. This way, an extra insulation zone is created in the middle chamber of the profile, boosting the system's energy performance by up to 38%.

ADVANCED SEALING SYSTEM

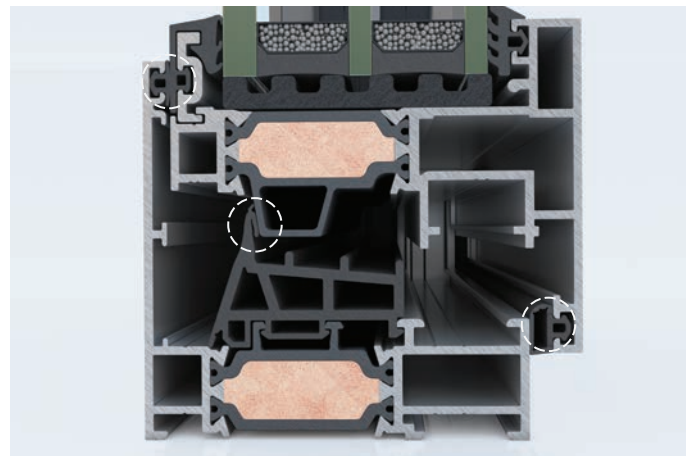

OPTIMAL 3-LEVEL SEALING

Optimal 3-level waterproofing with specially designed EPDM and co-extruded gaskets.

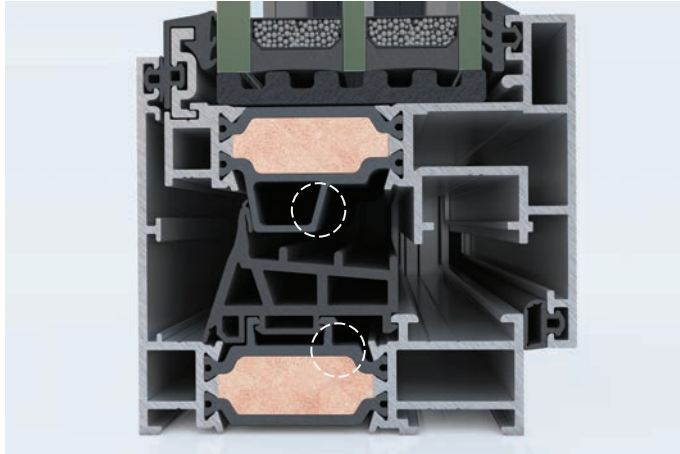

WIDE INSULATING BARS 32mm

Wide insulating bars of 32mm with glass fiber re-enforcement 25%, are applied to all system profiles, offering high thermal insulation levels and extra rigidity.

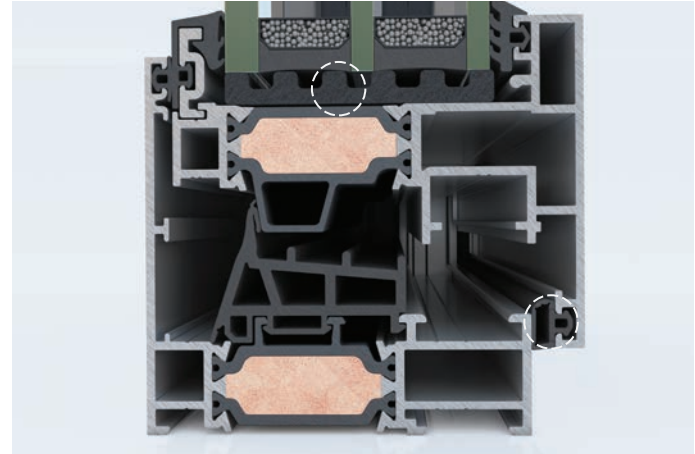

CO-EXTRUDED GASKET & FOAM INSULATING PROFILE

Co-extruded gasket is used in the perimetrical area of the window, improving energy performance. Whilst foam insulating profile is fitted below the glazing zone, minimizing thermal energy loss.



EPDM CORNERS

Special vulcanized EPDM corners ensuring maximum sealing at edge corners of the window, even at extreme weather conditions.

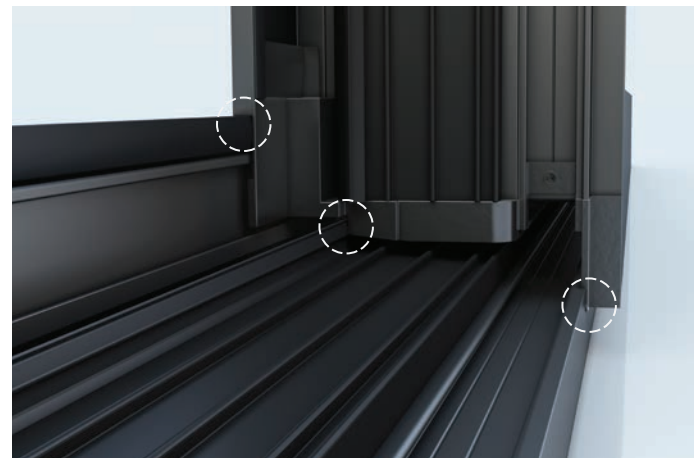

EPDM ADJOINING PROFILE END CUP

The EPDM adjoining profile end cap ensures excellent waterproof performance, even on double sash typologies.

The **TECHNOLOGY**

It's details like this that fulfil the highest requirements in terms of endurance.

Feel a high level of durability the benefits of which you will enjoy overtime.

DURABILITY FOR A LIFE TIME

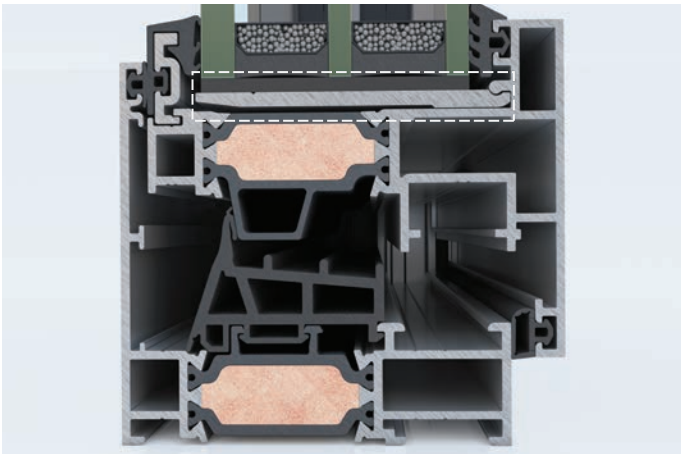

SUPPORT FOR GLAZING LOAD TRANSFER

This kind of support transfers the weight of the glass to the inner side of the window sash where all the functional elements of the mechanism are positioned. This way excellent functionality and smooth operation of the window are ensured for a life time, regardless of the weight of the glass.

LOOKING FOR THE BIG PICTURE

We are committed to an ambitious policy aimed at limiting the direct and indirect impacts of our activities on the environment, throughout the life cycle of our products.

ELVIAL always sets more ambitious targets for reducing environmental pollution and aims to help its customers reduce emissions through greener aluminum products.

GOALS WE ACHIEVE:

- // We have the right suppliers - suppliers dedicated to responsible practices and innovative ways in order to reduce carbon footprint.
- // We're committed to the highest standards in aluminium recycling, and always looking for new opportunities through investment, technology and innovation.
- // We drive to minimize waste in every possible way. From the materials we purchase to the aluminium we use, the goal is always zero waste.
- // We implement a certified environmental management system (ISO 14001).

The **ENERGY LEVELS**

Different conditions in environment and climate demand tailored solutions.

There are four energy level variables to this product so you can devise the best answer to any demand.

LEVEL 1 | $U_f: \geq 1.8 \text{ W/m}^2\text{K}$

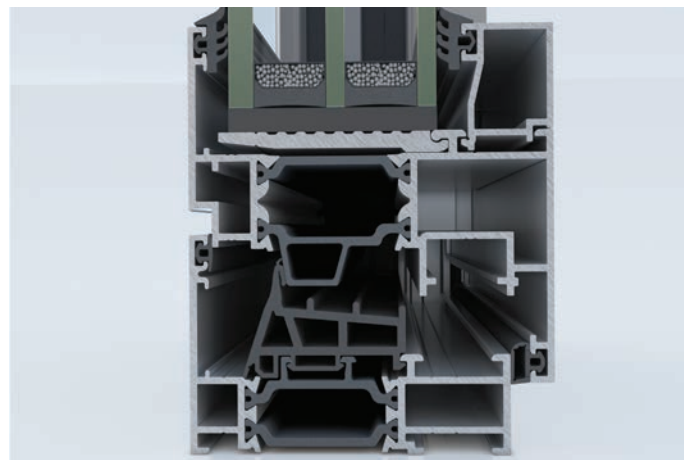

BASIC

LEVEL 2 | Uf: ≥ 1.2 W/m²K

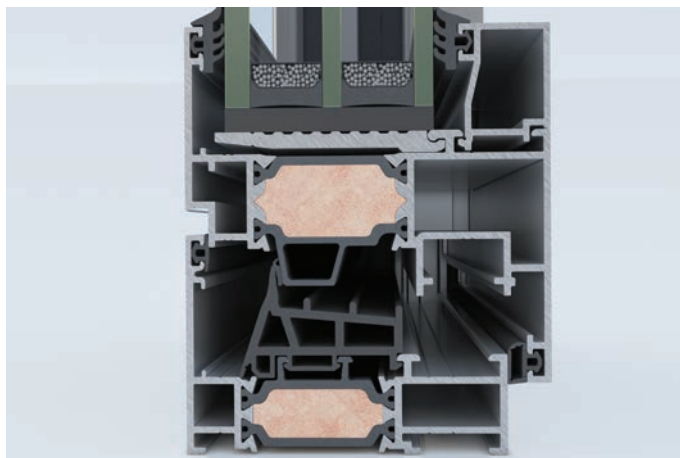

ELVIAL I² _ INNOVATIVE INSULATION TECHNOLOGY

LEVEL 3 | Uf: ≥ 1.1 W/m²K

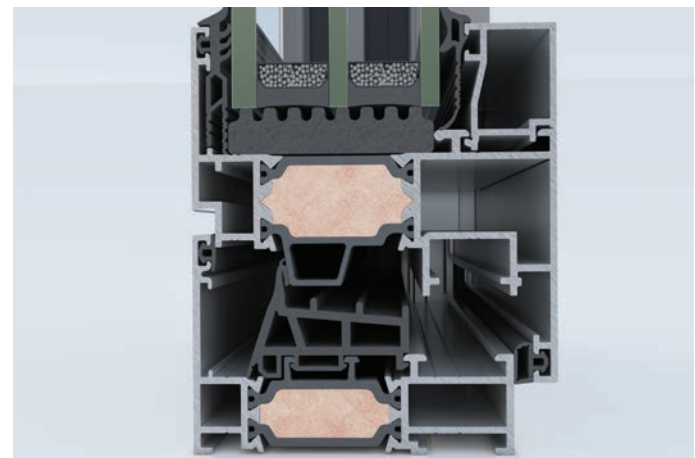







ELVIAL I² _ INNOVATIVE INSULATION TECHNOLOGY
FOAM INSULATING PROFILE & GLAZING GASKETS WITH FINS

The IDENTITY

It's a feeling. It's precious. What should be kept outside -noise, water, wind- is kept outside. What's inside is safe and sound. This is where we set our boundaries and keep them intact.

The performance of ESSENCE W67 HI² on all factors affecting interior environment is outstanding and certified by the German Institute Ift Rosenheim.

		<u>BS</u>	<u>CLASSIC</u>
Frame Depth		67 mm	67 mm
Min Face Height <i>Frame - Sash</i>		66 mm	89 mm
Min Face Height <i>Threshold - Sash</i>		56 mm	79 mm
Min Face Width <i>Middle Mullion</i>		78 mm	154 mm
Max Sash Height		2.500 mm	2.800 mm
Max Sash Width		1.400 mm	1.400 mm
Max Sash Weight		130 kg	180 kg
Max Glass Thickness		46 mm or 41 mm or 28 mm	60 mm



The PERFORMANCE

Create the maximum impact.
Enjoy less frame and more of everything else; warmth, comfort, light and scenery.

<u>CHARACTERISTIC</u>	<u>STANDARD</u>	<u>VALUE</u>
ENERGY		
Thermal Insulation Uf	EN ISO 10077-2	≥1.1 [Classic] ≥1.2 [BS]
COMFORT		
Air Permeability	EN 12207	Class 4 [600Pa]
Watertightness	EN 12208	E1050 [1.050Pa]
Resistance to Wind Load	EN 12210	C5 / B5 [2.000Pa]
Sound Reduction	EN 10140-2	38 dB
NAFS		
AAMA Rating		Class AW
PG Rating		100

The TYPOLOGIES

ESSENCE W67 HI² offers a plethora of construction solutions that will definitely exceed your expectations and deliver projects with unparalleled character.

INWARD OPENING CONSTRUCTIONS



Single sash fixed

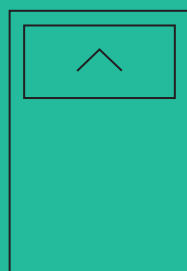

Single sash fixed with skylight

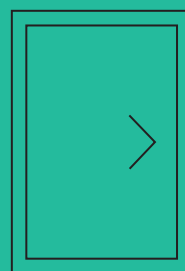

Single sash opening

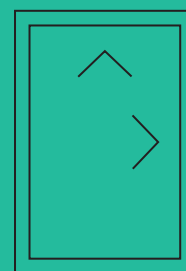

Single sash tilt & turn

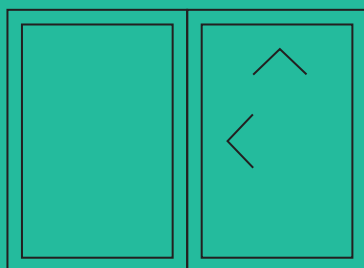

Single sash tilt & turn with fixed part

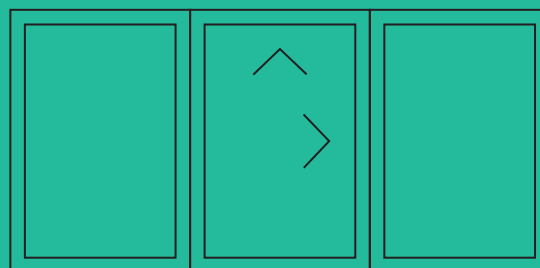

Single sash tilt & turn with fixed parts using contractions and expansions

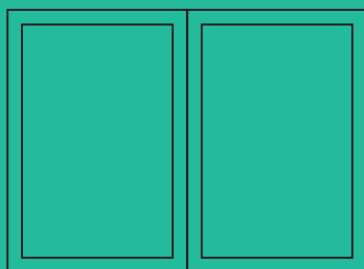

Double sash fixed

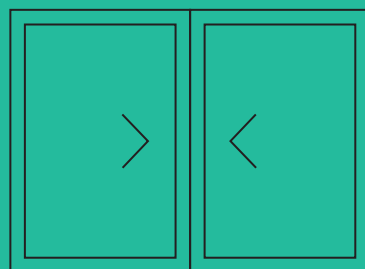

Double sash opening

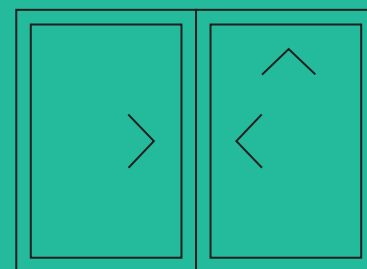

Double sash tilt & turn

OUTWARD OPENING CONSTRUCTIONS

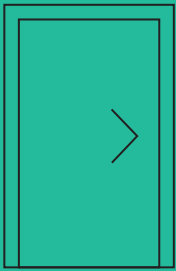

Single sash opening window door

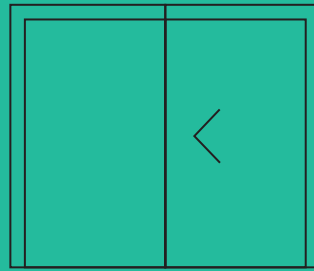

Single sash opening window door with fixed part

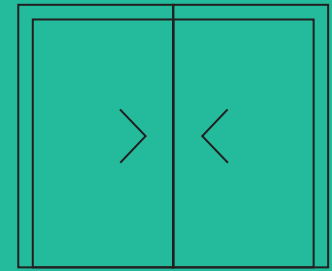

Double sash opening window door



Single sash projected

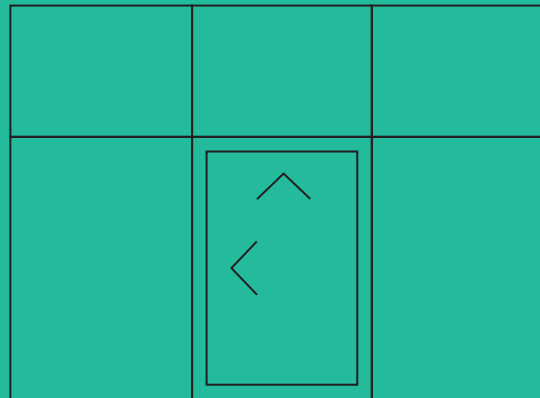

Special typology window wall

The **FINISHINGS**

The right choice of color may uplift the aesthetic result and add value to the building image, contributing, at the same time, to the well-being of everyday users.

There are 2 basic technologies developed for surface treatment. Powder Coating and Anodizing.

BUT if you want to achieve the ultimate combination of these 2 methods the solution is given by Pre-anodizing.



ELVIAL PRE-ANODIZING 2IN1

- // Zero waiting time
- // Spotless environment
- // Robotic handling

THIS IS WHAT

ELVIAL Pre-Anodizing 2in1 is all about.

ELVIAL owns the first in Greece and one out of seven worldwide, fully automated serial pre-anodizing and powder coating lines.

ELVIAL Pre-Anodizing 2in1 facility is robotic. No human hand meddles with the materials; the production environment is free of dust and other aggravating factors.

The profiles are subdued to an electrochemical procedure identical to that of anodizing.

STRONGER THAN TIME. STRONGER THAN ELEMENTS.

The aluminum profiles are placed in an underground tunnel and submerged in a sulfuric acid solution. Pre-anodizing produces an anodic substrate on the surface of the aluminum profile that protects it from corrosion.

Then the profiles are serially painted, eliminating waiting time, whilst the pores on the aluminium surface of the profile are completely sealed.

Pre-anodized aluminum profiles are automatically categorized as **Sea Proof Plus**.

ELVIAL Pre-Anodizing 2in1 is uniquely combined with Class 2 Super Durable powder coatings.



Our **COLOR COLLECTION**

Colors can be playful and eye catching. They can be soothing and encompassing. The hues and textures are of utmost importance because they highlight the design.

We form them keeping in mind prominent architects' preferences and international trends.

This is
ELVIAL COLOR COLLECTION
[Favorites_ Express and Favorites]

CLASS 2 SUPER DURABLE

Do the right choice.

Combine pre-anodizing with class 2 powder coating colours. Achieve maximum anti-corosion and radiance resistance, even under extreme sun light.

The super durable powder coatings are 3 times more resistant to sun radiation and render the profiles practically indestructible.

AMMOS.7024

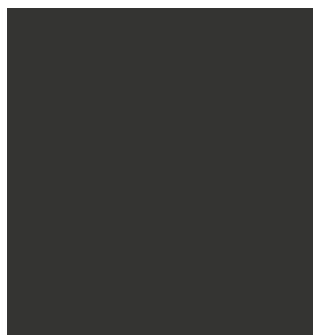

SAHARA.503

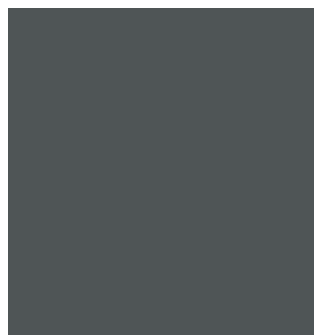

SAHARA.507

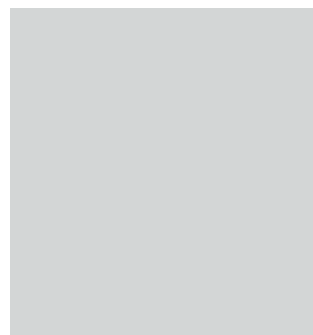

YW365F.GRIS 2150

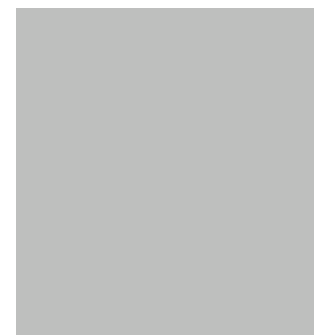

STR.3004



SAHARA.509

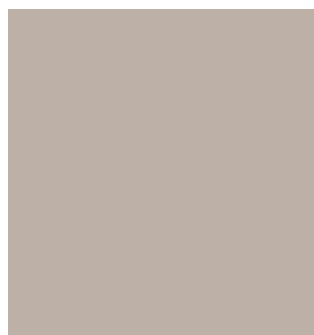

MESOGILOS.807

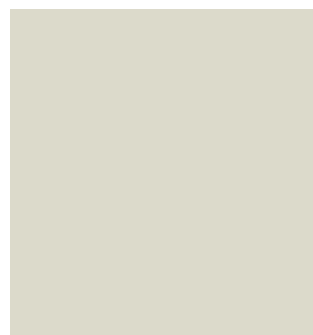

AMMOS.9010

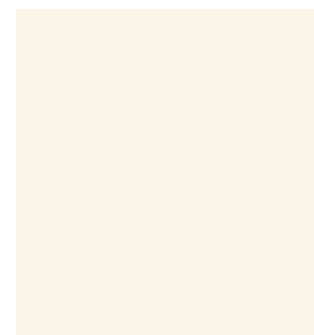

MESOGILOS.815

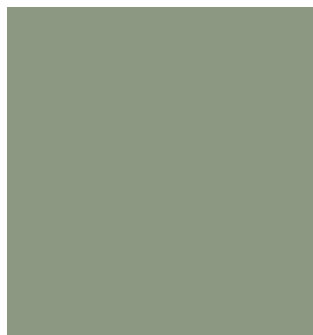

MESOGILOS.813



STR.7037



MESOGILOS.809

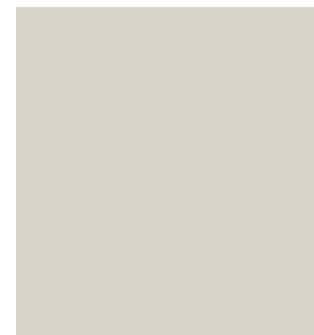

FIND OUT
MORE

AMMOS.7047

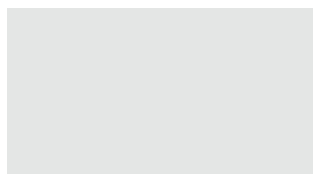

YW356F.GRIS 2800



STR.3005



AMMOS.9005



Our **SUPPORT**

WE ARE HERE FOR YOU

We always search for technology, for design and beyond that we search for excellence.

We collaborate as a strong team, in order to give you that.

We answer to technical or non-technical questions, we offer a wide range of products always having in mind that you control unique and demanding projects.

We act quickly and instantly because everything we do impacts on your customers; so you need to operate effectively.



ELVIAL FOR YOU

- // Technical manuals
- // dwg and BIM files
- // Section drawings
- // Construction plans and structural calculations
- // Customized solutions in order to fit the specifications
- // Certificates for Uf, wind loads, water tightness, air permeability

ELVIAL FOR YOUR CLIENTS

- // B2C brochures
- // Samples for colors in order to see and feel finishings and textures
- // Product boxes
- // Reference projects from our product collections

However all that matters in the end is the delivered quality. ELVIAL has a certified network of partners, with extensive experience and excellent training that will complete projects in accordance with timelines and high quality standards.

**INNOVATIVE TECHNOLOGIES_
ELVIAL PRE-ANODIZING 2IN1_
ELVIAL I² INSULATION TECHNOLOGY_
BE DIFFERENT.**



Please observe the relevant technical product information, which can be obtained online at www.rehau.com/ti. Subject to technical changes.

window.rehau.mk/elvial

This document is protected by copyright. All rights based on this are reserved. No part of this publication may be translated, reproduced or transmitted in any form or by any similar means, electronic or mechanical, photocopying, recording or otherwise, or stored in a data retrieval system.

© РЕХАУ дооел
ул. Борис Трајковски 76Б
1000 Скопје, Македонија

ELV1.W67.MK.202311