

Enhancing lives

ELVIAL W59 HI²
ALUMINIUM WINDOW
SYSTEM



REHAU
Window Solutions

elvial

**INNOVATIVE TECHNOLOGIES_
ELVIAL PRE-ANODIZING 2IN1_
ELVIAL I² INSULATION TECHNOLOGY_
BE DIFFERENT.**

MEDITERRANEAN BEAUTY.

THE FIRST DESIGN INSPIRATIONS
ALWAYS COME FROM
ARCHETYPAL SCENES; THE
IMAGES THAT CREATED OUR
PERSPECTIVES, THE WINDS THAT
COOLED OUR SUMMERS AND
THE COLOURS THAT PAINTED
OUR MEMORIES. THIS
COLLECTION IS ONE OF OUR
BEST SELLING CREATIONS AND

IT CARRIES ALL THE BEAUTY
THAT WE UNCONSCIOUSLY
CAME TO APPRECIATE AND ALL
THE QUALITY WE SEEK WITH
DETERMINATION. THE
INSPIRATION COMES FROM A
PLACE OF MANY IDENTITIES AND
MANY IMAGES; THE
MEDITERRANEAN.

ELVIAL W59 SI²

This collection had to measure up to bustling capital cities, to windswept, cosmopolitan islands, to islands with multifaceted inland and coastal areas with busy ports.

We created this collection as a homage to the beauty of the natural environment around the Mediterranean and the spirit of its cities. Which are generous, gentle and gracious.



THE LINEAR DESIGN



ROUNDED & LINEAR

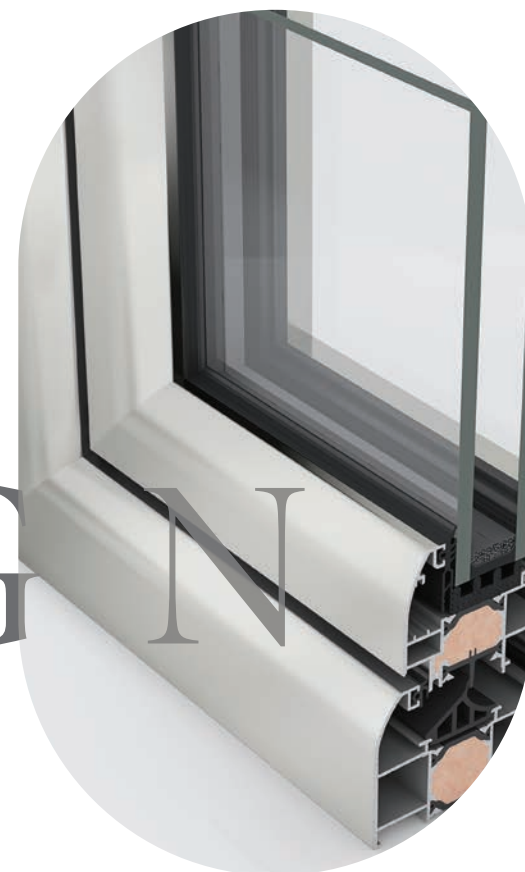

THE ROUNDED DESIGN

ELVIAL W59 SI² ML

Imagine a place where novelties and custom co -exist in a wonderful accord, where everything is measured by how it achieves balance between antagonistic elements and where what you imagine can be realized and shared with a community.

This is the inspiration we drew upon to create W59 SI² ML.









WA VES

The beauty of fundamental elements is the Mediterranean kind of beautiful.

Rugged lines co-exist with softer curves, like when a rock melts into a beach.

This system's curve can blend into the construction and be combined with different architectural styles to develop an alluring image.

ELVIAL W59 SI² CE

All countries around the Mediterranean boast of centuries long history and its traces on the housing areas.

These co-exist with daily commutes, frolicking in various venues, work in modern or older buildings, rest in safe spaces.

All this action needs a secure environment. We help create it and become part of the area's life.









WI NDS

Time challenges all preconceived perceptions.

There are things that stand the test of time and prove that the excellent rendition of fundamentals is a sure way to success.

Things like these gain the title of "a classic" and are always the right choice.

Attention to Detail.

W59 SI² is an excellent choice for projects that come together as an assembly of different elements to answer to various functional demands but still need to have a cohesive aesthetic identity.

This protean quality renders it a best seller among its peers.



THE PREEMINENT SHAPE

The fine line around this profile is a connecting element; a link that shows our evolution and our constant quest to create solutions that cover various lifestyle choices and various aesthetic orientations. This one is especially designed for those who enjoy a clear manifestation of limit and a visual affirmation of coziness.



JOINED BY AESTHETICS

This could be a lesson in tailoring. The glass profile and the shading profile are fitted on the same frame. The construction volume is minimized and the visual impression is upgraded, while the system's durability remains intact. The result is this solution which you will enjoy for many years to come.



EXCEL AT THE FUNDAMENTALS

Highly durable, easy to fit and utterly reliable. These are the fundamentals upon which all our solutions are built. This solution high scores in all fundamentals and smooths the process of installation, which is a challenge for angular constructions. It is also more than adequate as far as the design is concerned, being an ELVIAL product.



Extra Features.

Form follows function, they said.
We glorified form by concealing the functional components.



AVAILABLE IN ML EDITIONS



Black, Inox Satine and Natural Anodized



AVAILABLE IN CE EDITIONS



Black, White and Grey



Handles are simple and discreet.
Modern colors add an extra touch to the overall look.



TOULON



Black, White and Grey

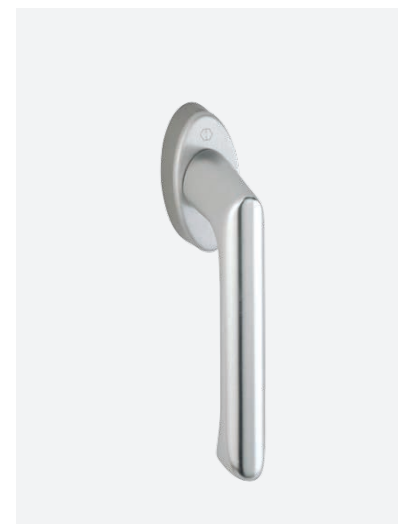

BREST



Black, White, Silver,
Bronze and Brown

The TECHNOLOGY

You can feel it on a cold night. You'll appreciate it on a hot day.
You'll love this when you run your budget.

HIGH THERMAL INSULATION

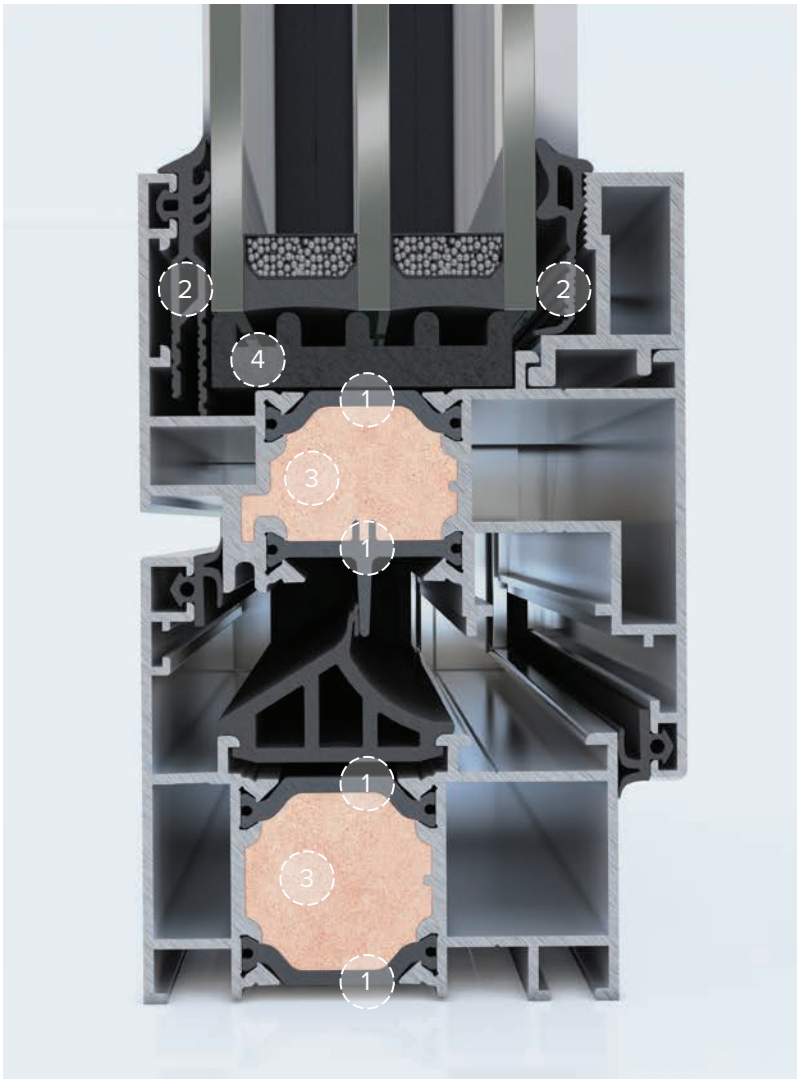

1 24MM INSULATING BARS

Wide insulating bars of 24mm, are applied to all system profiles, offering high thermal insulation levels and extra sense of amenity.

2 GLAZING GASKETS WITH FINS

Glazing gaskets with fins minimize the heat transfer under the glazing zone.

3 ELVIAL I² _ INNOVATIVE INSULATION TECHNOLOGY

The Innovation, ELVIAL I² Technology, is applied on all system's profiles.

This way, an extra insulation zone is created in the middle chamber of the profile, boosting the system's energy performance [Uf] by up to 38%.

4 FOAM INSULATING PROFILE

Foam insulating profile is fitted at the perimeter of the glazing zone, minimizing thermal energy loss.

This system is fitted with our Total Sealing System.

The vulcanization and assembly of this profile secures your space from the whims of the weather.

TOTAL SEALING SYSTEM

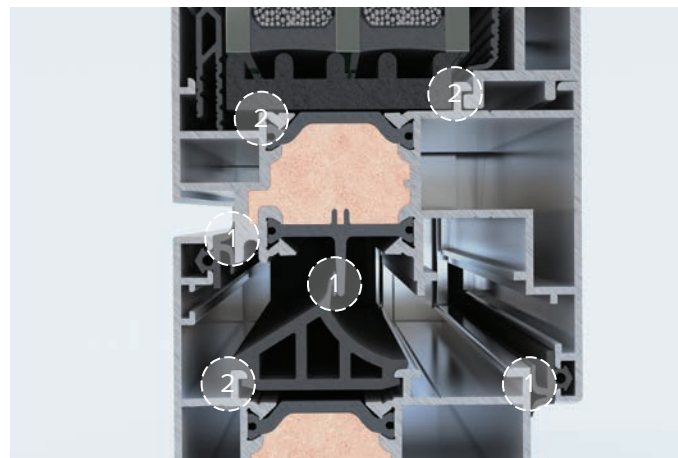

1 OPTIMAL 3-LEVEL WATERPROOFING

Optimal 3-level waterproofing with specially designed EPDM gaskets.

2 DRAINAGE CHANNELS

All system profiles are equipped with special drainage channels to prevent the water flow to the inner part of the window.

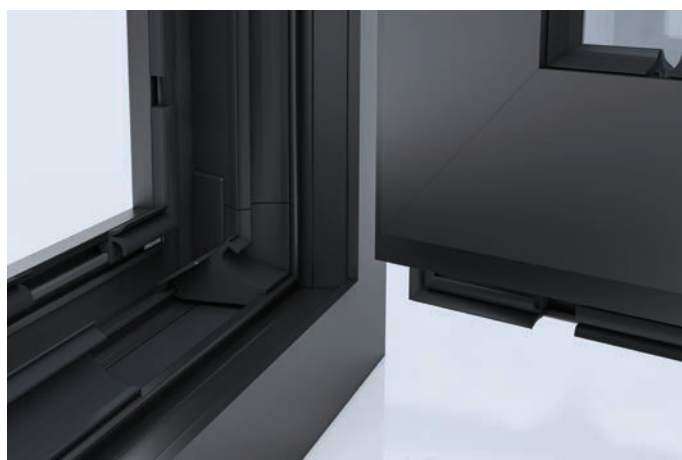

EPDM GASKET CORNERS

Special, vulcanized EPDM corners ensuring maximum sealing at edge corners of the window, even at extreme weather conditions.

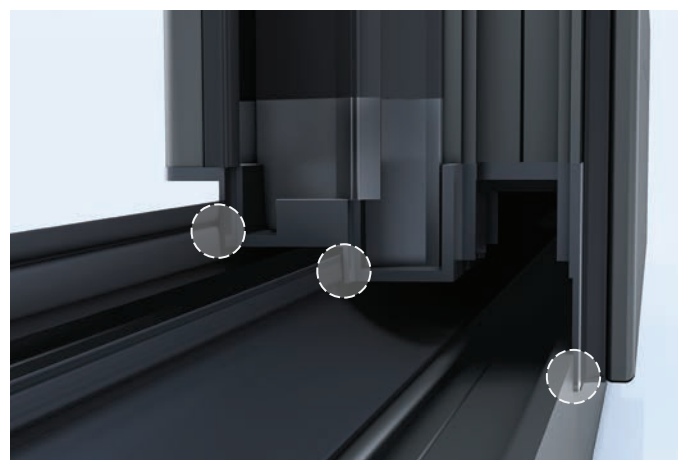

EPDM SPECIMEN FOR ADJOINING PROFILE END CAP

Double sash typologies are fitted with a special EDPM component that connects the mullion with the central gasket. The construction is flawlessly adjoined and practically impermeable even in extreme conditions.

The **ENERGY LEVELS**

Different conditions in environment and climate demand tailored solutions.

There are THREE energy level variables to this product so you can devise the best answer to any demand.

LEVEL 1 | Uf: ≥ 2.0 W/m²K

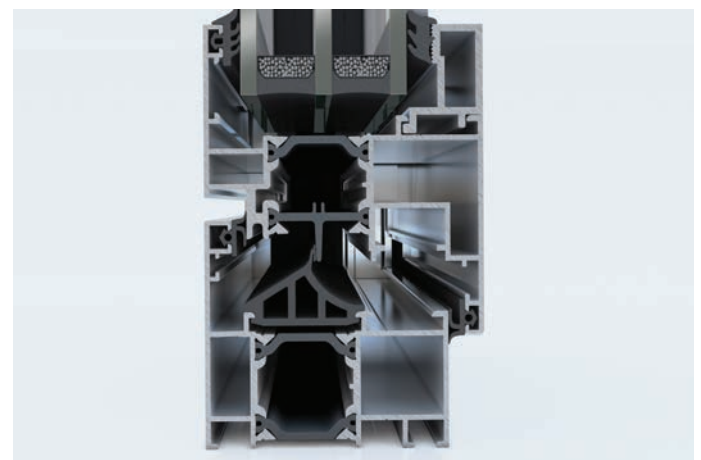

BASIC

LEVEL 2 | Uf: ≥ 1.7 W/m²K

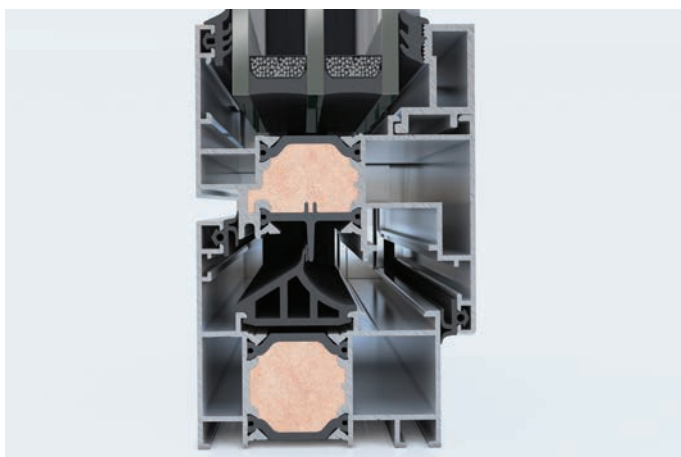

ELVIAL I² _ INNOVATIVE INSULATION TECHNOLOGY

LEVEL 3 | Uf: ≥ 1.6 W/m²K

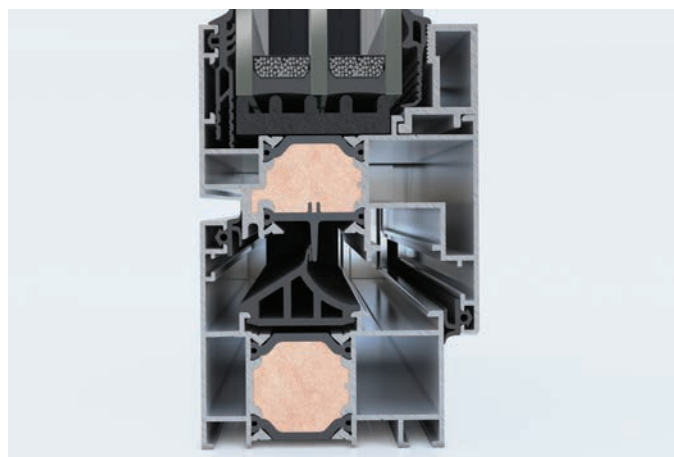

ELVIAL I² _ INNOVATIVE INSULATION TECHNOLOGY
FOAM INSULATING PROFILE
GASKET WITH FINS

The IDENTITY

A place feels like home when you define it. You draw a line between what belongs there and what does not. Your people, your work, things important to you belong there. With this solution you will create a beautiful environment to host them.

Its leading performance in all factors affecting interior environment is certified by Ift Institute Rosenheim in Germany. You may consult the performance index for each edition's specific performance.

Frame Depth		58.6 mm
Min Face Height <i>Frame - Sash</i>		94.1 mm
Min Face Height <i>Threshold - Sash</i>		107.5 mm
Min Face Width <i>Middle Mullion</i>		155.7 mm
Max Sash Height		2.300 mm
Max Sash Width		1.000 mm
Max Sash Weight		130 kg
Max Glass Thickness		46 mm

The PERFORMANCE

The climate in the Mediterranean is so beautiful. The region enjoys many sunny days during the year. In cases this does not happen the ELVIAL W59 SI² will make sure you don't feel it. In your space it will always be spring.

<u>CHARACTERISTIC</u>	<u>STANDARD</u>	<u>VALUE</u>
ENERGY		
Thermal Insulation Uf	EN ISO 10077-2	≥ 1.8 W/m²K
COMFORT		
Air Permeability	EN 12207	Class 4 [600Pa]
Watertightness	EN 12208	E1650 [1.650Pa]
Resistance to Wind Load	EN 12210	C5 / B5 [2.000Pa]
Sound Reduction	EN 10140-2	40dB
NAFS		
AAMA Rating		Class CW
PG Rating		100



The TYPOLOGIES

ELVIAL W59 SI² offers a plethora of construction solutions that will definitely exceed your expectations and deliver projects with unparalleled character.

INWARD OPENING CONSTRUCTIONS

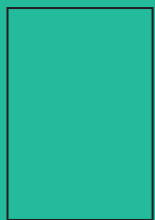

Single sash fixed

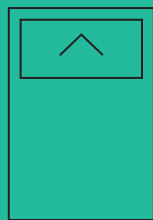

Single sash fixed with skylight

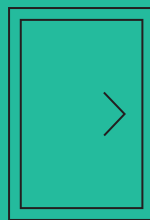

Single sash opening

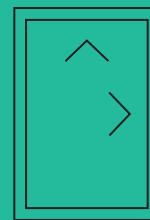

Single sash tilt & turn

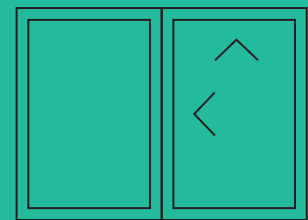

Single sash tilt & turn with fixed part

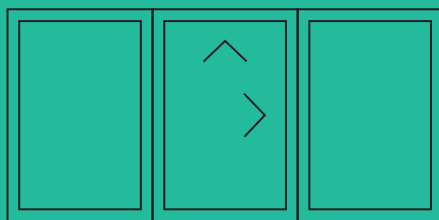

Single sash tilt & turn with fixed parts using contractions and expansions

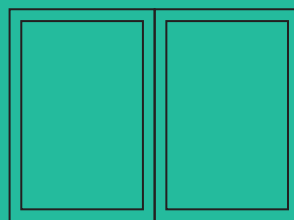

Double sash fixed

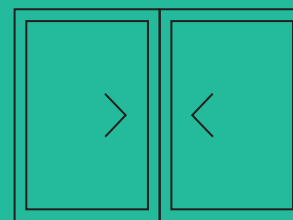

Double sash opening

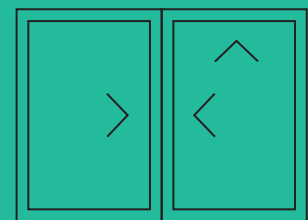

Double sash tilt & turn



Double sash angular fixed



Double sash angular tilt & turn



Single sash pivot with vertical axis



Single sash pivot with horizontal axis

OUTWARD OPENING CONSTRUCTIONS

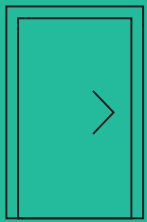

Single sash opening window door

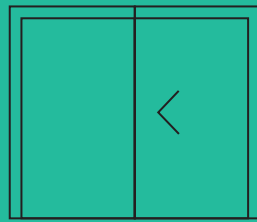

Single sash opening window door with fixed part

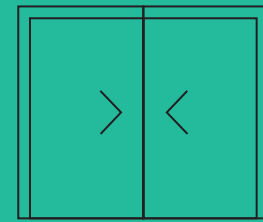

Double sash opening window door



Single sash projected

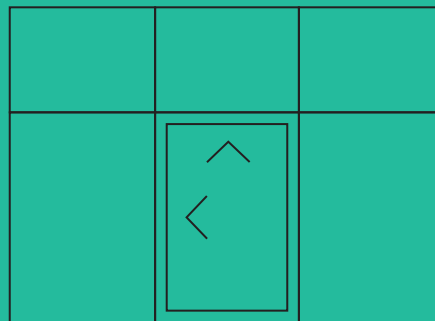

Special typology window wall

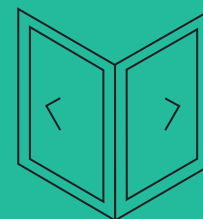

Double sash angular opening

The **FINISHINGS**

The right choice of color may uplift the aesthetic result and add value to the building image, contributing, at the same time, to the well-being of everyday users.

There are 2 basic technologies developed for surface treatment. Powder Coating and Anodizing.

BUT if you want to achieve the ultimate combination of these 2 methods the solution is given by Pre-anodizing.



ELVIAL PRE-ANODIZING 2IN1

- // Zero waiting time
- // Spotless environment
- // Robotic handling

THIS IS WHAT

ELVIAL Pre-Anodizing 2in1 is all about.

ELVIAL owns the first in Greece and one out of seven worldwide, fully automated serial pre-anodizing and powder coating lines.

ELVIAL Pre-Anodizing 2in1 facility is robotic. No human hand meddles with the materials; the production environment is free of dust and other aggravating factors.

The profiles are subdued to an electrochemical procedure identical to that of anodizing.

STRONGER THAN TIME. STRONGER THAN ELEMENTS.

The aluminum profiles are placed in an underground tunnel and submerged in a sulfuric acid solution. Pre-anodizing produces an anodic substrate on the surface of the aluminum profile that protects it from corrosion.

Then the profiles are serially painted, eliminating waiting time, whilst the pores on the aluminium surface of the profile are completely sealed.

Pre-anodized aluminum profiles are automatically categorized as **Sea Proof Plus**.

ELVIAL Pre-Anodizing 2in1 is uniquely combined with Class 2 Super Durable powder coatings.



Our COLOR COLLECTION

Colors can be playful and eye catching. They can be soothing and encompassing. The hues and textures are of utmost importance because they highlight the design.

We form them keeping in mind prominent architects' preferences and international trends.

This is
ELVIAL COLOR COLLECTION
[Favorites_ Express and Favorites]

CLASS 2 SUPER DURABLE

Do the right choice.

Combine pre-anodizing with class 2 powder coating colours. Achieve maximum anti-corosion and radiance resistance, even under extreme sun light.

The super durable powder coatings are 3 times more resistant to sun radiation and render the profiles practically indestructible.

AMMOS.7024

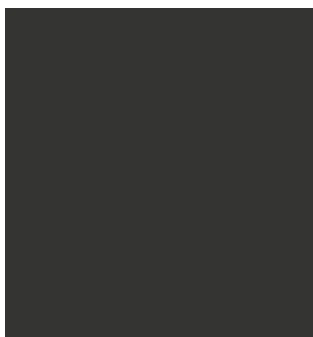

SAHARA.503



SAHARA.507

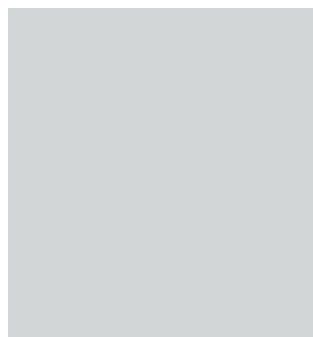

YW365F.GRIS 2150

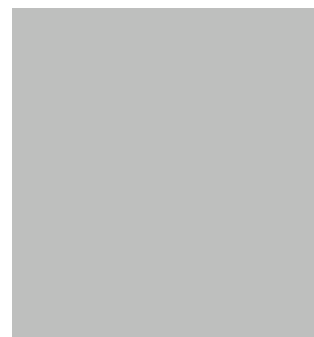

STR.3004



SAHARA.509

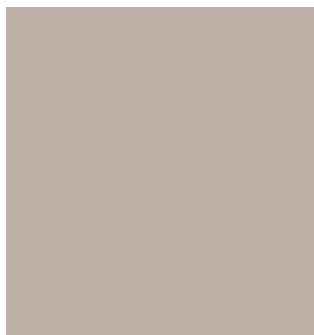

MESOGILOS.807

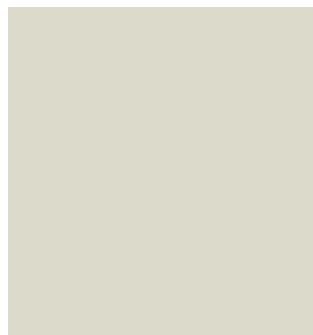

AMMOS.9010

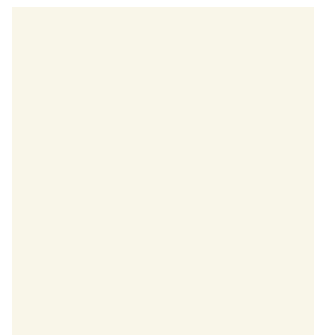

MESOGILOS.815



MESOGILOS.813



STR.7037



MESOGILOS.809

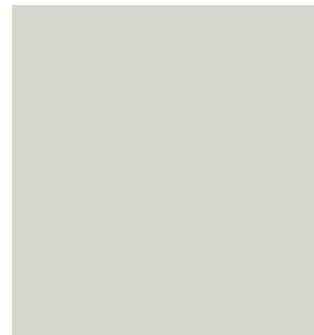

FIND OUT
MORE

AMMOS.7047

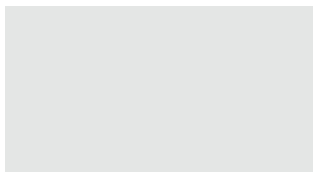

YW356F.GRIS 2800



STR.3005



AMMOS.9005



**INNOVATIVE TECHNOLOGIES_
ELVIAL PRE-ANODIZING 2IN1_
ELVIAL I² INSULATION TECHNOLOGY_
BE DIFFERENT.**



Please observe the relevant technical product information, which can be obtained online at www.rehau.com/ti. Subject to technical changes.

window.rehau.mk/elvial

This document is protected by copyright. All rights based on this are reserved. No part of this publication may be translated, reproduced or transmitted in any form or by any similar means, electronic or mechanical, photocopying, recording or otherwise, or stored in a data retrieval system.

© PEKAV доел
ул. Борис Трајковски 76Б
1000 Скопје, Македонија

ELV1.W59.EN.202311